



# **Gazelle™ Device Family Installation Manual**





## Table of contents

1	Introduction .....	3
1.1	About .....	3
1.2	How to use this Guide.....	3
1.3	Before you start.....	4
1.4	Counter Variants.....	5
2	Surface Mount Installation.....	7
2.1	About .....	7
2.2	Requirements:.....	7
2.3	Base Features.....	7
2.4	Installation Procedure:.....	8
3	Recess Mount Installation.....	11
3.1	About .....	11
3.2	Requirements .....	11
3.3	Base Features.....	11
3.4	Installation Procedure.....	12
4	Cabling .....	17
4.1	Power Options .....	17
4.1.1	Powering Multiple Units.....	17
4.2	IP Connections.....	18
4.3	Relay Output Connections .....	19
4.4	Relay Input Connections .....	20
4.5	CAN Interface Connections .....	22
4.5.1	CAN Interface Terminations.....	23
5	Configuration.....	24
5.1	Counter Configuration.....	24
5.1	SD Card .....	25

**WARNING:** This is a Class A product. In a domestic environment this product may cause radio frequency interference, in which case the user may be required to take adequate measures.





# 1 Introduction

## 1.1 About

This guide assists with the installation of Irisys Gazelle series people counters once a suitable position has been determined. It discusses installation of both surface-mount and recess-mount variants.

For help in deciding the optimum position to install Irisys people counters please refer to the Application Notes and Quick Start Guide documents. 'E-Learning' online training is also available.

Once installed, also remember that Irisys counters must then be configured using the Irisys People Counter Setup Tool (PCST) software for their installed environment. See separate documentation for details of this procedure.

All installers should logon to the Irisys Partner Portal and go through the Irisys official training presentation before attempting to install counters and configure them.

## 1.2 How to use this Guide

There are a number of different Irisys people counter models and variants (see section 1.4), but essentially all unit types are installed in exactly the same way with only the wiring connections for power and data out (relay and/or IP connection) between differing models varying. This is discussed in the cabling section (section 4).

When using this guide some sections only relate to a particular variant and some will apply to both IP and relay units. The sections are marked as below to indicate which variants it applies to:

Additionally, a number of boxouts will be shown at appropriate points:

	This type of boxout denotes very important information or instructions that must be followed.
---	---

	This type of boxout denotes relevant information which may be of interest in certain applications.
---	--

	This type of boxout denotes a useful piece of information (hints) that may not have been immediately obvious but which could be helpful in the future.
---	--





### 1.3 Before you start

Before you start fixing and drilling holes, be mindful of where the counter is going to go in relation to the door and other obstacles. In all cases the counter should be no less than 1m from the door and in most cases much further than this.

It is strongly recommended that the additional mounting location documentation, and e-learning material, available on the Irisys Partner Portal, is fully understood before you attempting to install a counter.

If you install the counter too close to the door, it will not be accurate!

 The Irisys Partner Portal has an extensive self-learning installation training section: <http://partnerportal.irisys.co.uk/>

 Do not install the counter directly onto anything like aircon units or heaters which can vibrate. The motors inside this units will disturb the sensing array and cause inaccurate counting.

 Be aware of any cables, pipes or other obstacles which may be located in the ceiling where the counter is to be installed.



1.4 Counter Variants

When installing Irisys Gazelle units be aware that the different variants look very similar. Always check the label and install, and connect, as required.

Master units are installed at every location. You can choose an IP output master or a relay output master. Node units are then added, as required, for wider entrances.

IP masters have relay outputs as well as an IP network connection and can further be specified as thermal only or DualView - thermal and video view - units.

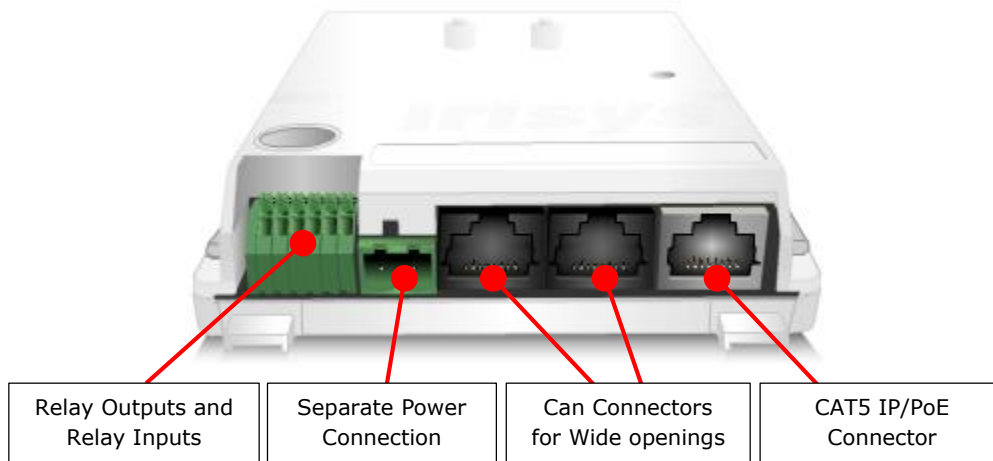

Figure 1.4.1 – IP Master Units (Including DualView Units)

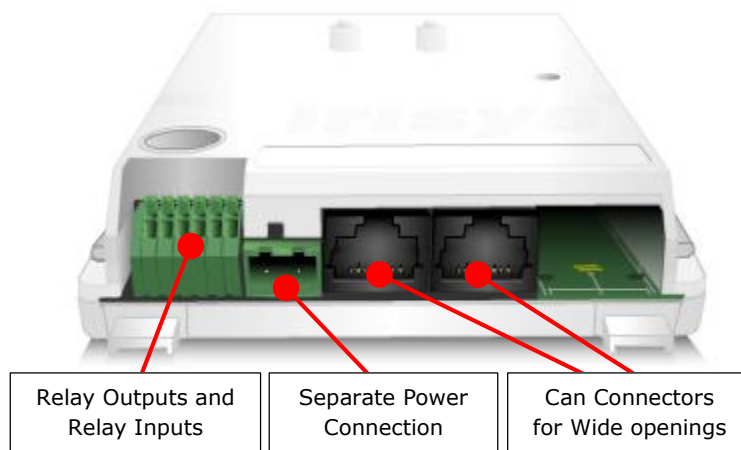



Figure 1.4.2 – Relay output Only Master Units

 Relay output-only master units have all the same connectors as an IP enabled units, except for the grey IP connector itself.

 Relay output-only master units have identical connectors to the node units so always check the part number on the label.

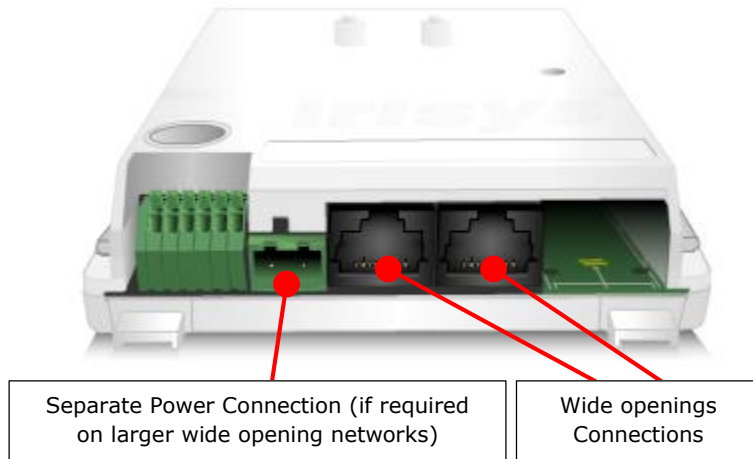



Figure 1.4.3 – Node Units

 Note that a non-IP enabled unit, such as a Relay output only unit, or a node unit, will not have the grey IP connector installed.

 Although node units have the Relay Output and Relay Inputs group of connectors on board – these are non-operational.



.....

## 2 Surface Mount Installation

### 2.1 About

The surface mount installation option results in a professional looking installation which is unobtrusive and will blend in to most ceilings. The top cover ensures that the cables are out of sight, although on ceiling cable runs are also provided for if required.

For a flush-to-ceiling fitting, and therefore an even more unobtrusive mounting option, see the Recess Mount Installation section 3.

 Remember that the surface mount kits are available in both White and Black versions, as are the Gazelle modules themselves, so pick the colour most applicable to your installation.

### 2.2 Requirements:

IRC5xxx-xx	The main Gazelle Counter 'core'
IWC500W or IWC500B	Surface Mounting Kit (in White or Black)
Fixings applicable to your installation (not supplied)	

Additionally you will also need:  
Screwdriver  
Drill & bits  
Spirit Level

### 2.3 Base Features

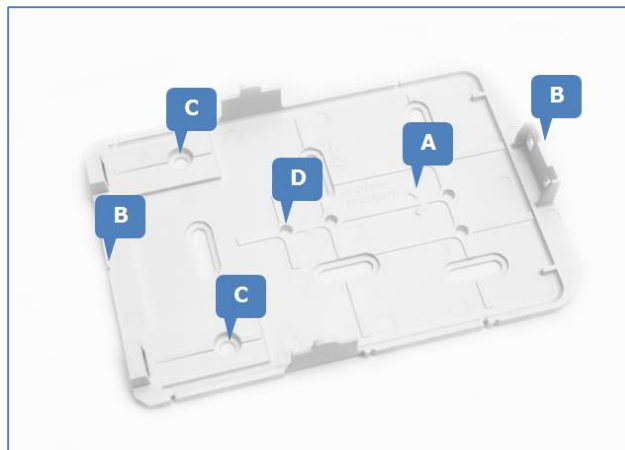

Figure 2.3.1

Each base has a 'Traffic Flow Direction' arrow as indicated by 'A' in Figure 2.3.1, above. The base should be installed so that this points in the direction of traffic flow – for ease of configuration and consistency of installations, Irisys recommends pointing the arrow *in* to the building, room, or the general area of interest.

Alignment marks are also provided at the edge of the base as shown as 'B'.





Although there are many fixing holes provided on the base, and you are free to use any, the fixing positions marked 'C' are the main fixing screw positions. Note that some of the fixing positions are recessed to allow the ends of the screws to be 'countersunk' and therefore to not interfere with the Gazelle core when it is later clipped into position.

The non-recessed holes can be used of fixing but indicate the position of the lenses as well as the centre of the base. Remember that the centre of the base is not the centre of the cover since the cover has additional space to hide the cable entry. The cover centre is indicated by 'D' in Figure 2.3.1.

## 2.4 Installation Procedure:

Align the 'Traffic Flow Direction' arrow so that the base points in the direction of traffic flow and fix to the ceiling.

 When installing multiple units as part of a wide opening network, all units must be installed with the Traffic Flow Direction arrow pointing in the same direction.

 Use the Alignment marks in conjunction with a laser line projected on the ceiling for perfectly aligned bases.

Install the base using the mounting holes provided. The slots allow for a limited amount of movement in the base. When the base is aligned correctly, tighten all screws and, if necessary, secure the base using one of the two locking screw positions shown as 'C' in Figure 2.3.1.

Check the base with a spirit level and pack underneath to achieve a level finish, if required.

Once the base has been secured in position, you can insert the core module into the base, but first remove the thermal lens cover and video lens cover (if present) from the core module. See Figure 2.4.1.

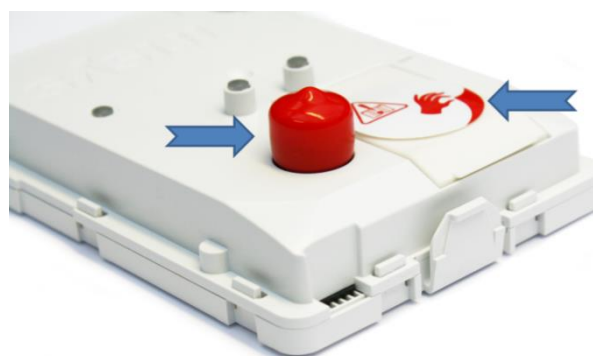



Figure 2.4.1

 When removing the red video lens cover, do not twist the cover, but instead prise it off so as to not move the video lens beneath.



.....

The Gazelle core module can then be clipped into the base by first inserting the two tabs at the connector end of the core into the base and then clipping the tab on the opposite face as shown in Figure 2.4.2. (Ensure the tab clips in place).



Figure 2.4.2

Cabling should now be connected as required. See section 4.

Remember that wiring can be hidden behind the top cover as long as the cable entry from the ceiling to the connectors is within the 30mm overhang space that the top cover provides, see Figure 2.4.3, below.

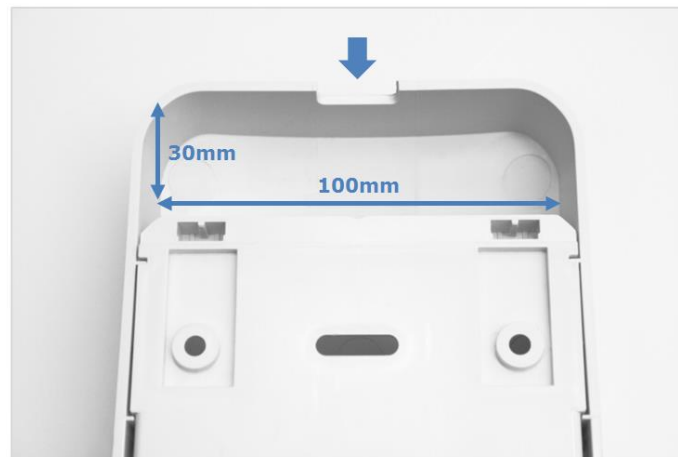

Figure 2.4.3

The top cover may be supplied with one or two blanking plugs. All units require the larger of the two blanking plugs to be removed as this is the thermal lens position. The smaller blanking plug is for the video lens and it too must be removed for use with video equipped models (e.g. IRC571x-xxx) but should be left in place for non-video units.

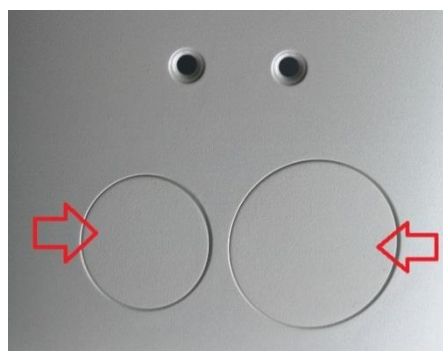

Figure 2.4.4

.....

The cover is clipped onto the base and can be removed for access by pressing the clips on either side with a small flat bladed screwdriver (see Figure 2.4.5). Take care to not damage the surface finish of the cover.



Figure 2.4.5



### 3 Recess Mount Installation

#### 3.1 About

The recess mount installation option results in a professional looking installation which is almost flat to the ceiling and is often over looked entirely due to its insignificance. All cables are completely hidden in the ceiling cavity, so ensure that an accessible cabling route can be realised.

The recess mount installation requires a small amount of space behind the ceiling to locate the base and wiring. Allow at least 31mm (1 ¼inches) from the front of the ceiling, and if not available, use the on ceiling base instead, see section 2.

Lastly check the ceiling where the base is to be installed with a spirit level. There is no facility to level the base on an irregular or uneven ceiling.

 Remember that the recess mount kits are available in both White and Black versions, as are the Gazelle core modules themselves, so pick the colour most applicable to your installation.

#### 3.2 Requirements

IRC5xxx-xx	The main Gazelle Counter 'core'
IWC510W or IWC510B	Recess Mounting Kit (in White or Black)
M4x25 screws are supplied (Qty 4)	but choose fixings applicable to your installation

Additionally you will also need:  
A drill & bits, also a 114mm (4½") Cutting saw attachment  
Hand or power saw  
Spirit Level

#### 3.3 Base Features

Each base has a 'Traffic Flow Direction' arrow as indicated by 'A' in Figure 3.3.1, below. The base should be installed so that this points in the direction of traffic flow – for ease of configuration and consistency of installations, Irisys recommends pointing the arrow *in* to the building, room, or the general area of interest.

Alignment marks are also provided at the edge of the base as shown as 'B'.

The two positions marked 'C' are the centre drill positions for the main cutouts in the ceiling required, see next section.

The fixing positions marked 'D' are the main fixing points. Note that these positions are recessed to allow the ends of the screws to be 'countersunk' and therefore to not interfere with the cover when it is clipped into position afterwards.



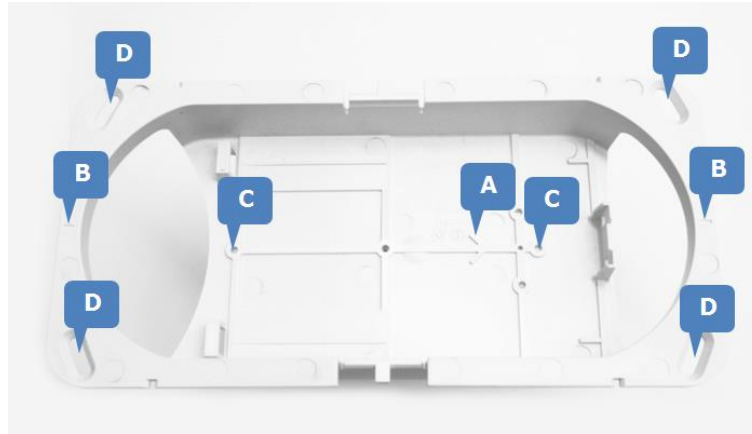



Figure 3.3.1

### 3.4 Installation Procedure

Ensure that the ceiling where the unit is to be installed is level – remember that the recess mount base provides limited shimming options for making the counter horizontal. If the ceiling is out by more than a few degrees, the on-ceiling surface mount base is the recommended alternative installation type as it allows some level of shimming.

Temporarily introduce the recess base to the ceiling where it will be installed and mark the drill points through the holes in the base ('C' in Figure 3.3.1). When doing this, ensure that the 'Traffic Flow Direction' arrow in the base points in the direction of traffic flow. Also use the Alignment marks ('B') as required.

 When installing multiple units as part of a wide opening network, all units must be installed with the Traffic Flow Direction arrow pointing in the same direction.

 Use the Alignment marks in conjunction with a laser line projected on the ceiling for perfectly aligned bases.

Now cut two holes with the 114 mm (4 1/2") hole saw with centres marked previously. Take care to avoid any obstacles behind the ceiling when cutting:

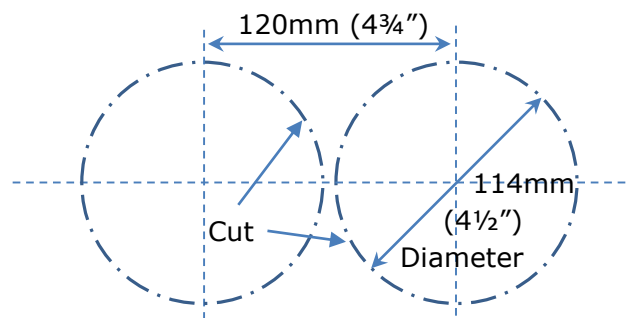

Figure 3.4.1

Then cut the two lengths between the circle diameters as marked by the dotted lines in Figure 3.4.2:

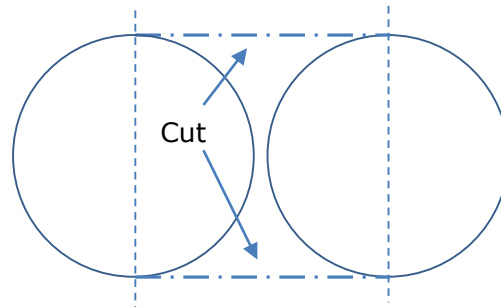

Figure 3.4.2

You will be left with one oblong hole in which the recess mount base will fit (Figure 3.4.3). Note that the hole will be slightly larger than the base to allow for fine alignment at the final stage of fitting:

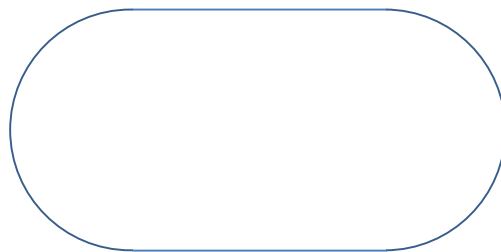

Figure 3.4.3

You can now insert the back plate into the hole and fix in place:



Figure 3.4.4

The recess mount can be secured with appropriate fixings through the four holes provided and into the ceiling material, if appropriate:



Figure 3.4.5

For some ceiling types and/or thinner ceilings, a load spreader will be required behind the base to support it and prevent the ceiling material from splitting and the base falling. Two semi-circular brackets are included for this purpose (below) and these are designed to connect through the ceiling to the base and hold it in place.



Figure 3.4.6

.....

The semi-circular brackets go behind the ceiling and attach to the recess base using 4 x M4 25 mm Countersunk Bolts, also supplied. In order to correctly position the semi-circular brackets and drill the required holes in the right place, temporarily locate the recess base into the newly cut hole and mark the hole positions:

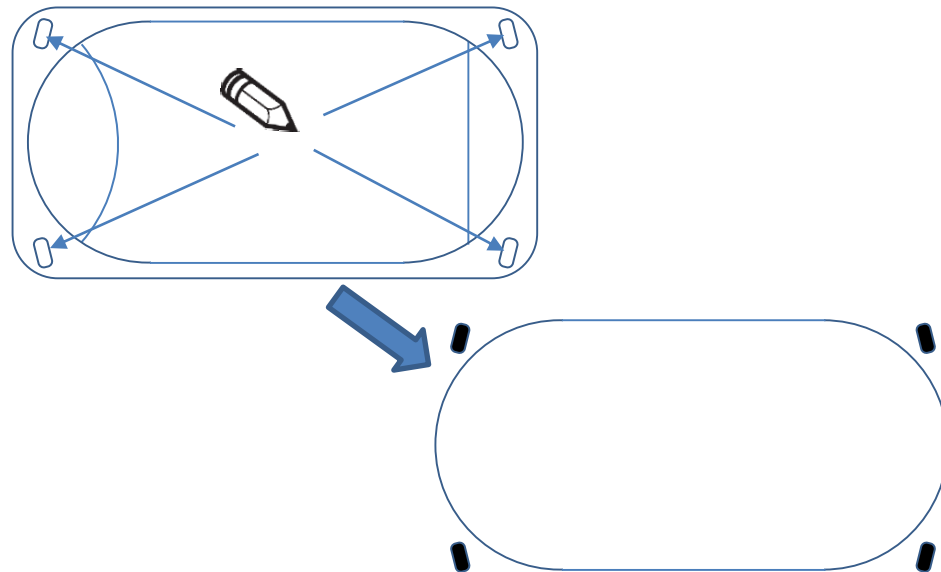

Figure 3.4.7

For thinner ceilings of up to 5mm thick the brackets should be used with the bushes uppermost. Drill a 5mm or 6mm diameter pilot hole to accommodate the supplied countersunk bolts:

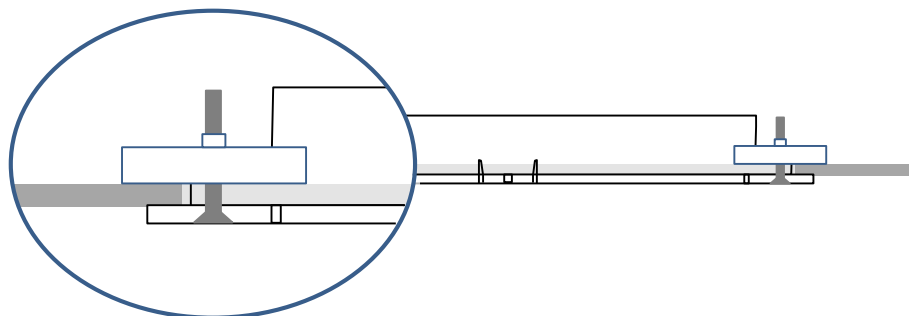

Figure 3.4.8 – Mounting for ceilings <5mm thick

But for thicker ceilings of over 5mm in depth, we recommend installing the brackets with the bushes recessed into the ceiling. Drill an 8mm (5/16") diameter pilot hole to accommodate the width of each of the bushes:

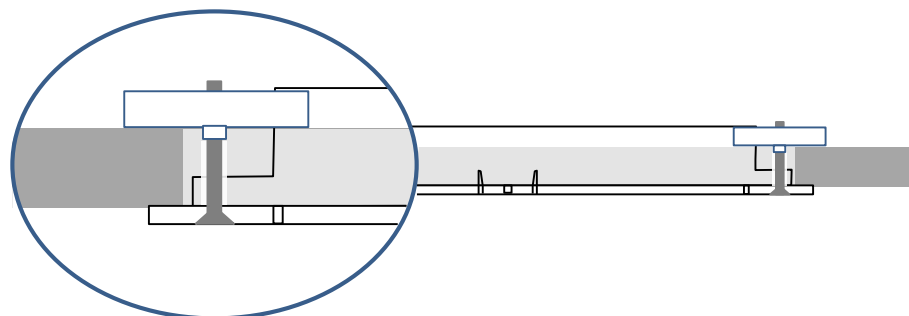

Figure 3.4.9 – Mounting for ceilings >5mm thick

.....

Now locate the base into the ceiling and then place the semi-circular brackets above the ceiling. Using the bolts provided to secure the bracket, loosely fix the base in place. Make a final check of the base alignment and then tighten the four bolts to secure the base in its final position.

Once the base has been secured, you can insert the core module, but first remove the thermal lens cover and video lens cover (if present) from the core module. See below:

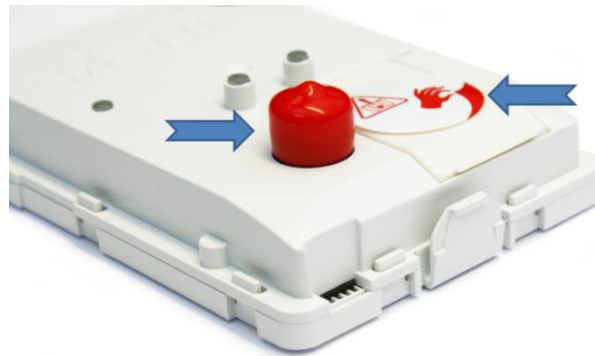



Figure 3.4.10

 When removing the red video lens cover, do not twist the cover, but instead prise it off so as to not move the video lens beneath.

The Gazelle core module can then be clipped into the base by first inserting the two tabs at the connector end of the core into the base and then clipping the tab on the opposite face as shown in Figure 3.4.11.



Figure 3.4.11

Cabling should now be connected as required. See section 4.

Remove any unrequired blanking plugs from the cover, which maybe pre-fitted, before installing:

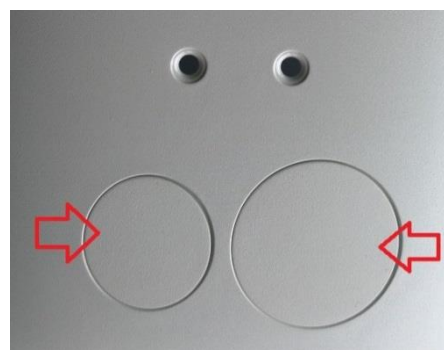

Figure 3.4.12

Once cabling and commissioning is complete (see below) the cover is clipped onto the base and can be removed for access by pressing the clips on either side with a small flat bladed screwdriver (Figure 3.4.13). Take care to not damage the surface finish of the cover or the ceiling when removing the top cover.



Figure 3.4.13



.....

## 4 Cabling

### 4.1 Power Options

The counter can be powered by a +12 to +28V DC power supply direct connection to the Green power connector; +24V DC power supplies are a recommended common type.

For non-IP enabled units (e.g. relay output only units) the green power connection is the only option for powering, but for IP units an alternative powering method is available..

For IP enabled units powering via a direct IP connection to a PoE enabled switch, or similar PoE (IEEE 802.3af or 802.sat) specification device, is the recommended method of powering.

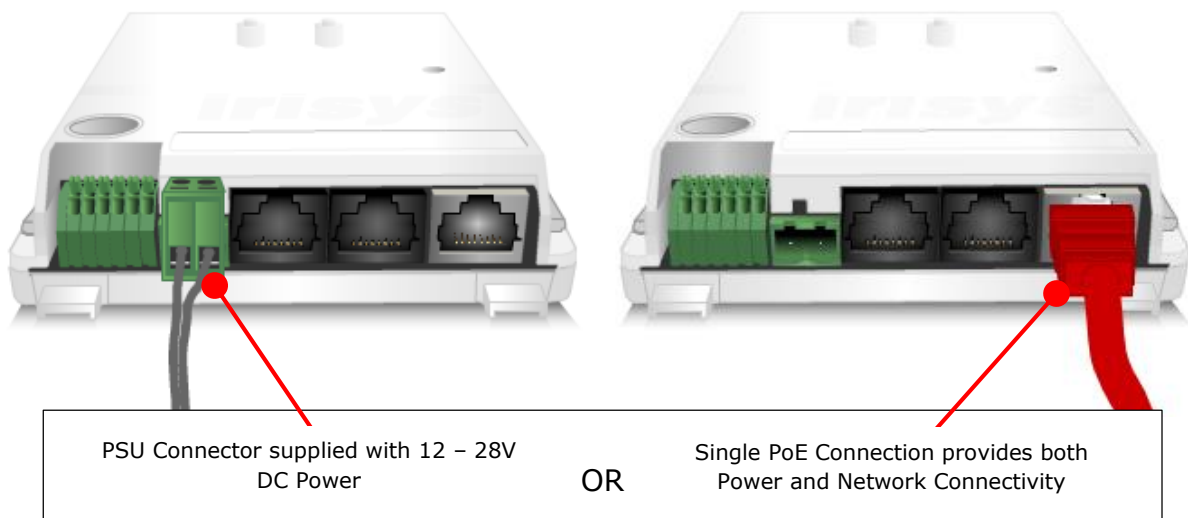





Figure 4.1.1 - IP Master unit with PoE Connection

 When you have both of the above powering options available to you (PoE & green power terminal), i.e. on an IP enabled unit - make only one power connection and never both of them!

 Take care to never accidentally connect a PoE connection to one of the Wide Opening CAN connections as damage could result!

 If a PoE switch is not available, any PoE sourcing equipment that complies with the PoE standard can be used. When no PoE sourcing equipment is available units must be powered using the green power connector

#### 4.1.1 Powering Multiple Units

In most cases powering multiple connected units together on a wide opening network, requires just one power connection to the master. The power is then distributed from the master to the nodes connected to it. Some limits apply - see 'CAN Interface Connections' section below.

.....

.....

## 4.2 IP Connections

IP enabled units are usually connected to an IP network for data collection as well as to take advantage of the remote setup, data collection and ongoing maintenance facilities it provides. (All IP enabled units also have Relay outputs too – see next section.)

When powering a device via PoE switch or other PoE sourcing equipment then this performs both the powering and communications functions and is all that is required for an IP connection.



Figure 4.2.1

 Powering an IP enabled unit via a PoE switch is the recommended method of powering as it only requires a single CAT5 cable connection.

If a PoE switch is not available and you are using the green power connection as an alternative, simply connect a standard CAT 5 IP connection to the grey RJ45 connector:

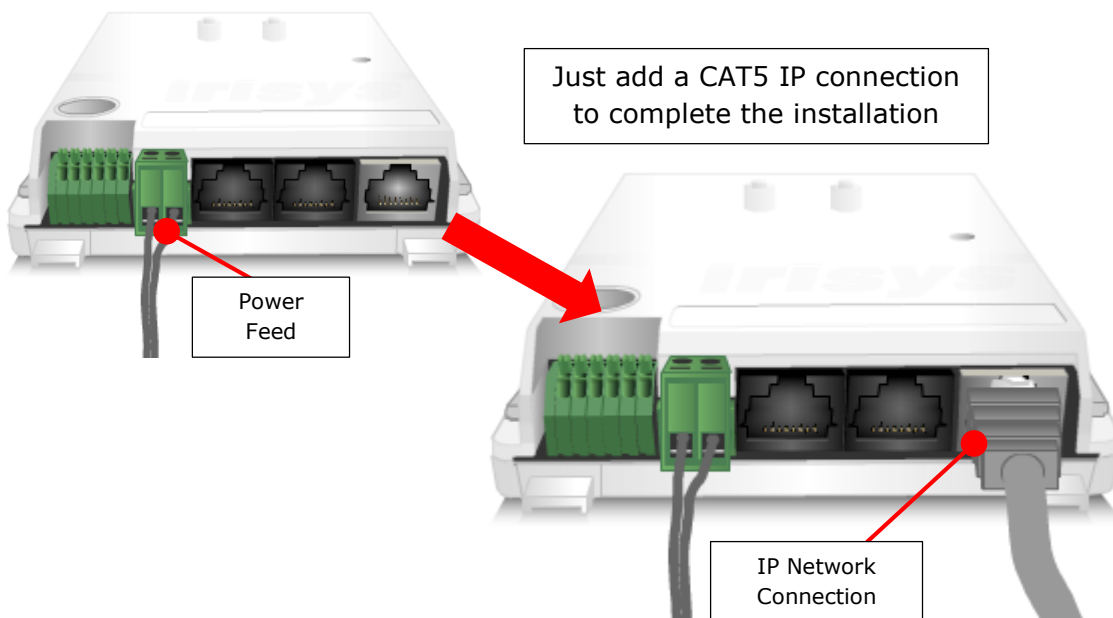



Figure 4.2.2 - IP Units with Non-PoE Connection & Separate Power Feed

 Do not exceed the maximum cable length of 100m (330ft) for the IP network cable connection.

.....

4.3 Relay Output Connections

Two relay outputs provide pulsed output of the data for integration into data loggers requiring these very simple types of connections. These are available on all the Gazelle master units, both relay only, and IP enabled units:

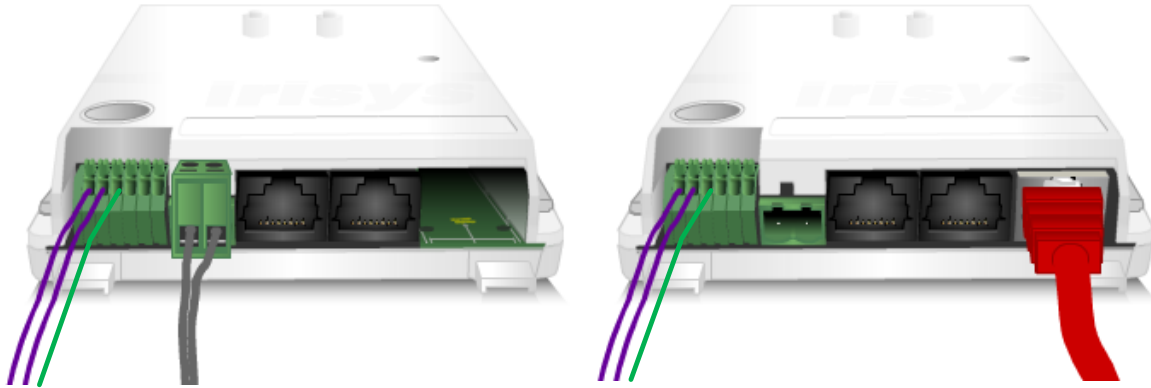
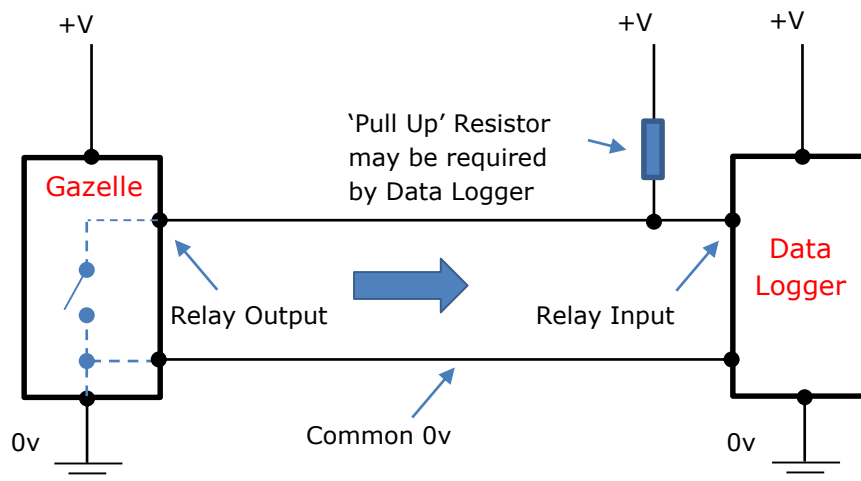

Figure 4.3.1

Each relay is wired to your data logger as follows:



The pull-up resistor may be required by your data logger, but some data loggers have this built in already - check with the logger manufacturer to be sure. If the resistor is required, insert the resistor at the data logger end of the cable. You can only insert it at the Gazelle side - at the green power connector - when NOT powering via PoE:

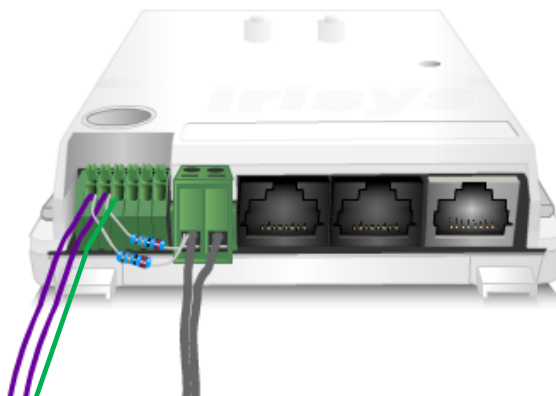

Figure 4.3.2



Remember that the pin out for the Relay connections is always shown on a label on the underside of the counter.

#### 4.4 Relay Input Connections

Gazelles have a further two relay inputs which allow data from other pulsed output devices (for example, beam break counters) to be input and integrated into the on-board data held in the counters flash memory for later access over the IP connection. This allows the Gazelle master unit to become a source of multiple data types – the on board line count registers, and registers assigned to the incoming pulses from external relay output sensors.

With IP enabled Gazelle masters the pulses coming in on each enabled input are stored in their own separate registers in exactly the same way that the regular line count data is. All active registers are then logged internally for retrieval over IP.

With Relay only Gazelle masters the incoming data can be re-output as required, potentially with a different pulse width or even as an inverted signal. In this way a Gazelle relay only master can perform a simple relay pulse conversion function if required.

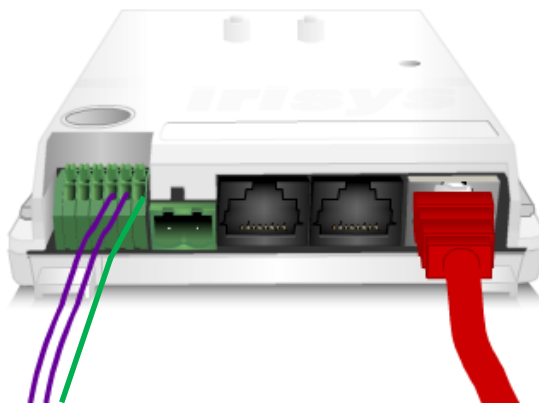
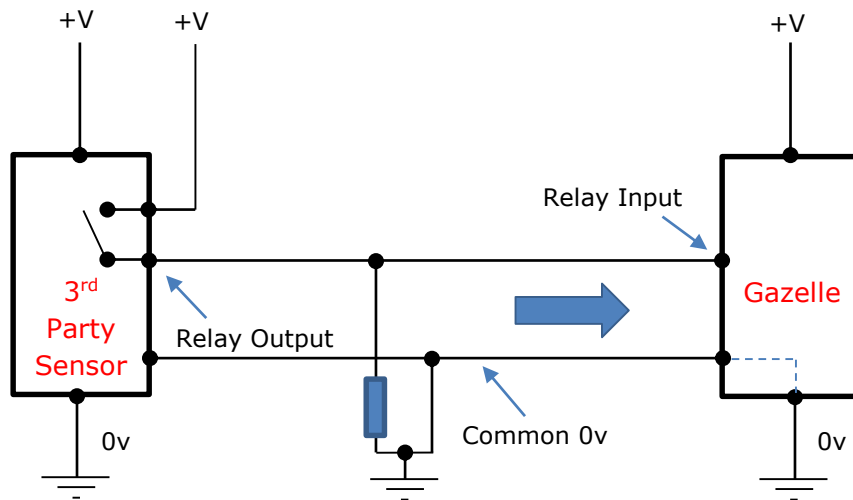

Figure 4.4.1

- Each input is referenced to ground
- A High level must be over 3.3V (max 28V)
- A Low Level must be below 1.0V (min 0V)
- (Between 1V - 3.3V will be indeterminate)
- The default Input state is low, pulled down via a 1Mohm Resistor to stop unused lines floating
- The user may need to apply their own pull down or pull down resistor dependant on application (between 1K $\Omega$  and 20K $\Omega$ )
- All inputs are de-bounced in software by sampling the level 3ms after state change
- All inputs are High impedance (1M $\Omega$ ) with an input of between 0-15 Volts. At 15-28Volts the impedance will be around 358k $\Omega$  due to protection circuitry beginning to conduct.

Each relay is wired to your data logger as follows:



💡 Remember that the pin out for the Relay connections is always shown on a label on the underside of the counter.

.....

#### 4.5 CAN Interface Connections

The CAN network protocol is used to allow two or more Irisys devices to communicate with each other. The main reason for using this is to allow units installed on a wide opening network to work together as it allows two or more units to pass target information to each other and effectively and efficiently track and count people across a much larger area than is provided by a single unit.

Additionally, the Irisys CAN I/O module also uses the CAN protocol and the same connections (see separate CAN I/O module installation sheet for more details).

All CAN enabled devices have two, black, CAN connectors provided to allow for a 'daisy chain' connection from one device on the bus, to the next. The wiring connection between devices is provided by a standard 'straight through' CAT5 patch lead, from device to device, to form a single logical CAN bus (devices cannot be star-wired).

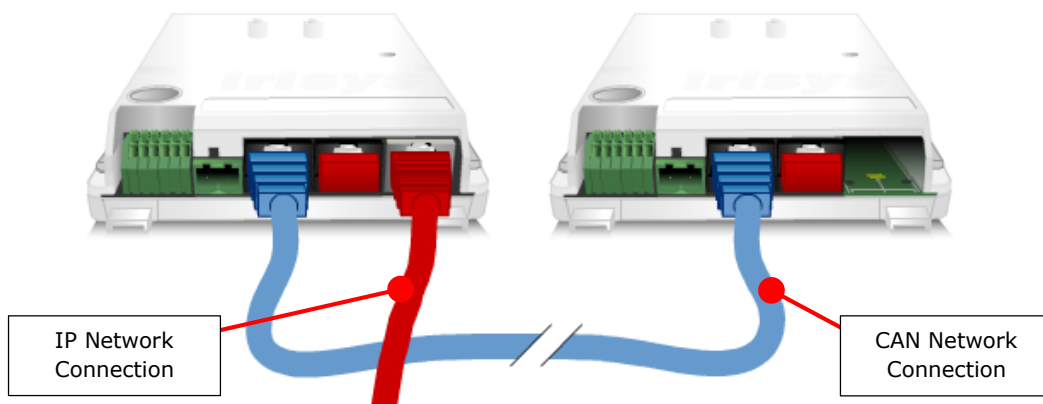







Figure 4.5.1

-  The two CAN connection sockets are internally wired together and therefore either of them can be used.
-  The network traffic between units on the bus utilises the CAN protocol and this is fully automatic once connected and configured correctly.
-  The CAT5 cable connection between devices will also distribute power to all devices on the bus from its point of entry on the network and so normally the only connection required – although be aware of maximum unit limits (below).
-  There may be a maximum of 4 nodes connected to an IP Master (IRC57xx-Mxx) counters CAN-Bus in a 'daisy-chain' style when using PoE (max 5 units in total).
-  When powering a wide opening network of 5 or more units, PoE cannot be used but also the power connection to the wide opening network must be made in the centre of the network, see below.

Because the master has two black CAN connectors, it can be placed in the middle of a group of nodes if required/more convenient.

DualView (IRC571x-Mx) counters have a wide angle video lens which will see the equivalent width of three thermal views. Therefore, a DualView unit should only ever be installed in wide opening networks of three units (or less) in order to still see the whole wide opening on the video view. The DualView unit should be positioned in the middle of two nodes so that its video view encompasses the same area as its own thermal view and that of the two nodes either side of it.

#### 4.5.1 CAN Interface Terminations

Devices at the first and last positions on the 'CAN-Bus' should be terminated correctly by inserting the CAN terminator (IWC3063) supplied, into the last free black RJ45 socket at each end of the CAN-Bus. Consequently, there should be no RJ45 sockets which do not contain either a cable or the CAN terminator.

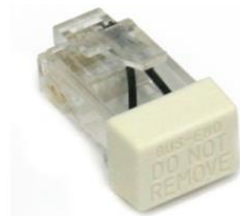

Figure 4.5.2

#### 4.5.2 Powering More than Five Units

Because the wide opening CAN network is a bus with RJ45 connectors are essentially multiple RJ45 connectors in series, there are current limits which you should be aware of.

As mentioned above in the main section, there are essentially two issues to note:

1. When connecting more than five units together, PoE cannot be used.
2. When connecting more than five units together – regardless of whether the master is IP or relay-only – the power connection to the network must be made to one of the units in the middle of the bus.

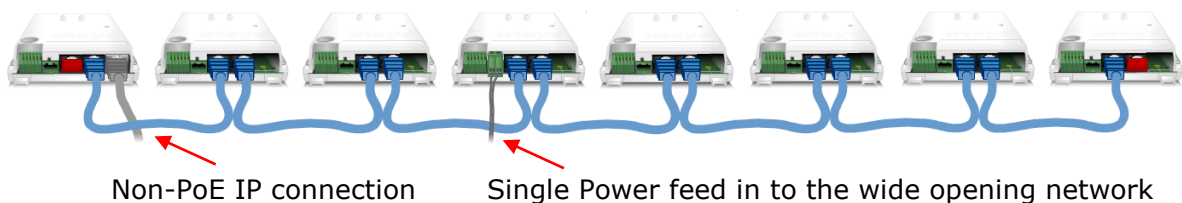



Figure 4.5.3

 When connecting an IP master to a PoE switch, you must either disable PoE output on the relevant port of the switch, or use some kind of isolation between the counter and the switch, such as the Irisys IWC3061 power injector (without power connected) which includes an isolation element.

.....

## 5 Configuration

### 5.1 Counter Configuration

Before use, all Irisys People Counter devices must first be configured to work in their installed location/environment. The People Counter Setup Tool software (PCST) is used to do this and is available as either an executable version that must be installed on the configuration PC, or as a web based application that runs on a web server hosted on IP versions of the counter.

All configuration options are loaded into a non-volatile storage area within the unit and are maintained, even after power down.

When configuring Irisys devices the following options must be configured:

- Count line settings (correct count line positioning is the key to accurate counting)
- Target tracking (ensuring that the counter is recognising and tracking people correctly)
- Network settings (required for all IP enabled devices)
- Relay output settings (correct interfacing with data loggers required for correct data retrieval)
- Relay input settings (require when accepting other pulsed sensor data into the Irisys device)

The PC used for configuration is connected to the counter via either an IP or serial connection, dependant on the model of counter to be configured. IP enabled models support both serial and IP connection, but relay enabled models support setup via serial only.

For configuration using a serial connection, the installed version of PCST must be used, in conjunction with a serial setup lead (part number IWC3062) connected directly to the counter:



Figure 5.1.1

For configuration over IP, you can use the installed version of the setup tool or the web based PCST in conjunction with a compatible Internet browser running the Microsoft Silverlight Add-on. It should be noted that configuration of an IP unit via the exe version of the software will not allow all settings to be configured, such as DNS Settings, or the

.....



Client connection settings. In some cases it may be necessary to configure the main counting functionality and basic IP settings, locally, via serial, and the other IP settings and Client settings via internet browser at the switch or other accessible network point.

IP enabled devices also allow for counter configuration via an Estate Manager connection provided you enter the required settings in order for an Estate Manager connection to be established in the first place. Specifically the counter must be present on the local network and have valid Client connection details entered (as well as a network path to Estate Manager). All counting settings can then be made remotely via the Estate Manager server. Estate Manager is the recommended day to day management solution for all IP enabled devices, but especially for all DualView devices.

For information on configuring the counter, refer to the People Counter Installation Training available from the E-learning section of the Irisys Partner Portal:

<http://partnerportal.irisys.co.uk/>

Use the self-signup option if you've never used the portal before and login details will be emailed to you.

## 5.1 SD Card

All Gazelle DualView counters (IRC57xx-Mxx) are supplied with a 4GB MicroSD card installed, for use when recording validation sequences to be used in the separate Validation Tool software. This may need to be re-seated if it has become dislodged in transit, as shown below.

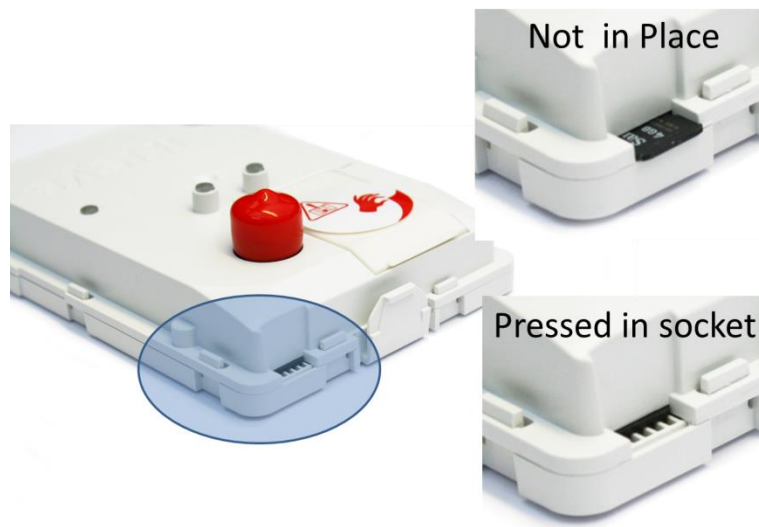

Figure 5.1.1

This card can be removed by pressing it in the socket and it will pop out. If there are issues reading the card it should be re-seated. Higher capacity cards can be used in order to increase the size & amount of validation recordings that can be made – consult Irisys for advice.



## InfraRed Integrated Systems Limited

Park Circle Tithe Barn Way Swan Valley  
Northampton NN4 9BG UK

Tel: **+44 (0) 1604 594 200**

Fax: **+44 (0) 1604 594 210**

Email: [counting.support@irisys.co.uk](mailto:counting.support@irisys.co.uk)  
[sales@irisys.co.uk](mailto:sales@irisys.co.uk)

Web site: [www.irisys.co.uk](http://www.irisys.co.uk)

## IRISYS Americas

One Glenlake Parkway  
Suite 700

Atlanta GA 30328 USA

Tel: **+1 678 638 6248**

Email: [support@irisys.net](mailto:support@irisys.net)  
[sales@irisys.net](mailto:sales@irisys.net)

Web site: [www.irisys.net](http://www.irisys.net)

© 2015 InfraRed Integrated Systems Limited (Irisys). No part of this publication may be reproduced without prior permission in writing from Irisys. This document gives only a general description of the products and except where expressly provided otherwise shall form no part of any contract. While Irisys will endeavour to ensure that any data contained in this product information is correct, Irisys do not warrant its accuracy or accept liability for any reliance on it. Irisys reserve the right to change the specification of the products and descriptions without notice. Prior to ordering products please check with Irisys for current specification details. This product may be protected by patents US5420419, US5895233. All brands and product names are acknowledged and may be trademarks or registered trademarks of their respective holders.

**September 2015**

**IPU 40520**

**Issue 2b**

