

Roger Access Control System

Installation guide for PR311SE/PR311SE-BK Access Controllers

Firmware version: 1.16.xxxx

Document version: Rev. F

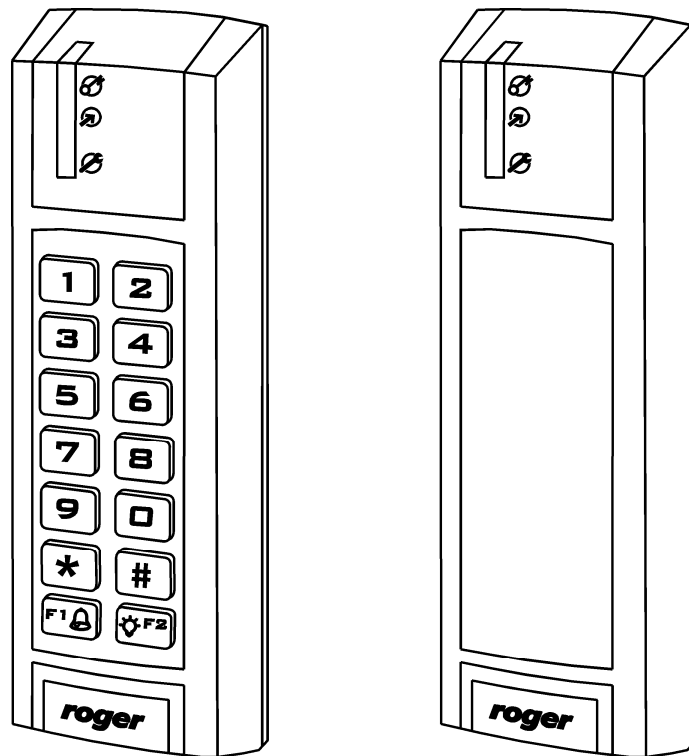

rcdr164

Contents

- 1. Introduction..... 3**
 - 1.1 This manual3
 - 1.2 Typing conventions.....3
- 2. Description and specification..... 4**
- 3. Installation 5**
 - 3.1 Wires and connection diagram.....5
 - 3.2 LED indicators6
 - 3.3 Power supply7
 - 3.4 Connection of door locking device.....7
 - 3.5 Connection of external reader and/or extension module.....8
 - 3.6 Input and output lines8
 - 3.6.1 Inputs.....8
 - 3.6.2 Relay outputs8
 - 3.6.3 General purpose outputs8
 - 3.7 RS485 communication bus8
 - 3.8 Controller mounting.....8
 - 3.8 Installation guidelines10
- 4. Configuration 11**
 - 4.1 Controller address11
 - 4.2 Memory Reset procedure12
 - 4.3 Controller programming13
 - 4.4 Firmware update13
- 5. Ordering information 15**

1. INTRODUCTION

1.1 This manual

This manual contains minimum information that is necessary to properly install the devices and to perform initial tests. Full functional description of the controllers and set of commands for manual programming is included in the document – PRxx1 series controllers, Functional description and Programming Guide, which is available at www.roger.pl.

If PR311SE and PR311SE-BK controllers are not clearly distinguished in particular paragraph, then information specified for PR311SE are also valid for PR311SE-BK. But if PR311SE-BK name is used in particular paragraph then the information concerns only that specific type of controller.

1.2 Typing conventions

Examples

italics letters

Specific names related to RACS4 system

with first capital letter

Notes

separated with two lines (upper, lower) from the standard text

2. DESCRIPTION AND SPECIFICATION

Both controllers with built-in readers i.e. PR311SE and PR311SE-BK are identical in regard of their functions, but only PR311SE is equipped with keypad.

The new, factory-made controller has the address ID=00 and is equipped with the MASTER card. The controller is equipped with built-in reader of EM125kHz standard, so the MASTER card can be used for the initial tests after installation and for manual programming of the controller.

Additional external reader of PRT series (Roger) operating in RACS Clock&Data mode can be connected to PR311SE if it is required to provide access control at both sides of the door.

PR311SE can be installed both outdoors and indoors and does not require special protection against rain and moisture.

The controller can be programmed by means of computer with PR Master software or alternatively by means of commands entered with keypad. PR311SE-BK, which is not equipped with keypad can also be programmed manually but in such case connection of external reader of PRT series with keypad is necessary (e.g. PRT12LT). PR311SE can be connected to PC by means of communication interface i.e. UT-2USB, UT-4DR or RUD-1.

Table 1. Specification	
Supply voltage	10-15VDC
Proximity cards	EM 125 kHz (UNIQUE), in accordance with EM4100/4102
Reading distance	Up to 15 cm for ISO cards (depends on card type and quality)
Current consumption	PR311SE: average 70mA PR311SE-BK: average 50mA
Tamper	Isolated contact, NC type, 24V/50 mA rated
Input lines IN1...IN3	NO/NC inputs, electrically biased to +12V via 15 kΩ resistor, triggering level app. 3.5V
Output REL1	Relay output with single NO/NC contact, 30V/1.5A max. load
Output lines IO1/IO2	Open collector transistor outputs, internally biased to +12V via 15 kΩ resistor, when active short to ground, rated 15VDC/1A
Distances	RS485 comm. bus: up to 1200m Between the reader and controller: max. 150 m Between controller and XM-2 expansion module: max. 150 m
Environmental class (according to EN 50131-1)	Class IV, outdoor general conditions, temperature: -25°C to +60°C, relative humidity: 10 to 95% (no condensation)
Dimensions HxWxD	152,5x46x23mm (standard enclosure base) 152,5x46x35mm (additional extended enclosure base - included)
Weight	approx. 150g
Certificates	CE

3. INSTALLATION

3.1 Wires and connection diagram

PR311SE controller is equipped with 0,5m connection cable including following wires.

Table 2. Wires		
Name	Colour	Description
+12V	Red	Positive power supply contact, 12V DC
GND	Black	Negative power supply contact and reference potential for RS485 communication bus, input lines and RACS Clock&Data bus
IN1	Pink	IN1 input line, internally connected to the power supply plus (+12V) through a 5.6k Ω resistor
IN2	Blue	IN2 input line, internally connected to the power supply plus (+12V) through a 5.6k Ω resistor
IN3	White-yellow	IN3 input line, internally connected to the power supply plus (+12V) through a 5.6k Ω resistor
RS485 A	Brown	RS485 communication bus
RS485 B	Green-white	RS485 communication bus
CLK	White	RACS Clock&Data bus (external reader, XM-2 module)
DTA	Green	RACS Clock&Data bus (external reader, XM-2 module)
TMP A	Grey	Anti-sabotage contact, line A, rated 24V/50mA
TMP B	Yellow	Anti-sabotage contact, line B, rated 24V/50mA
IO1	Yellow-brown	IO1 transistor output of open collector type, rated 15V DC/1.0A
IO2	Green-brown	IO2 transistor output of open collector type, rated 15V DC/1.0A
REL1-NC	Grey-pink	REL1 relay output, contact normally closed, rated 30V/1.5A
REL1-COM	Red-blue	REL1 relay output, common contact, rated 30V/1.5A
REL1-NO	Violet	REL1 relay output, contact normally opened, rated 30V/1.5A

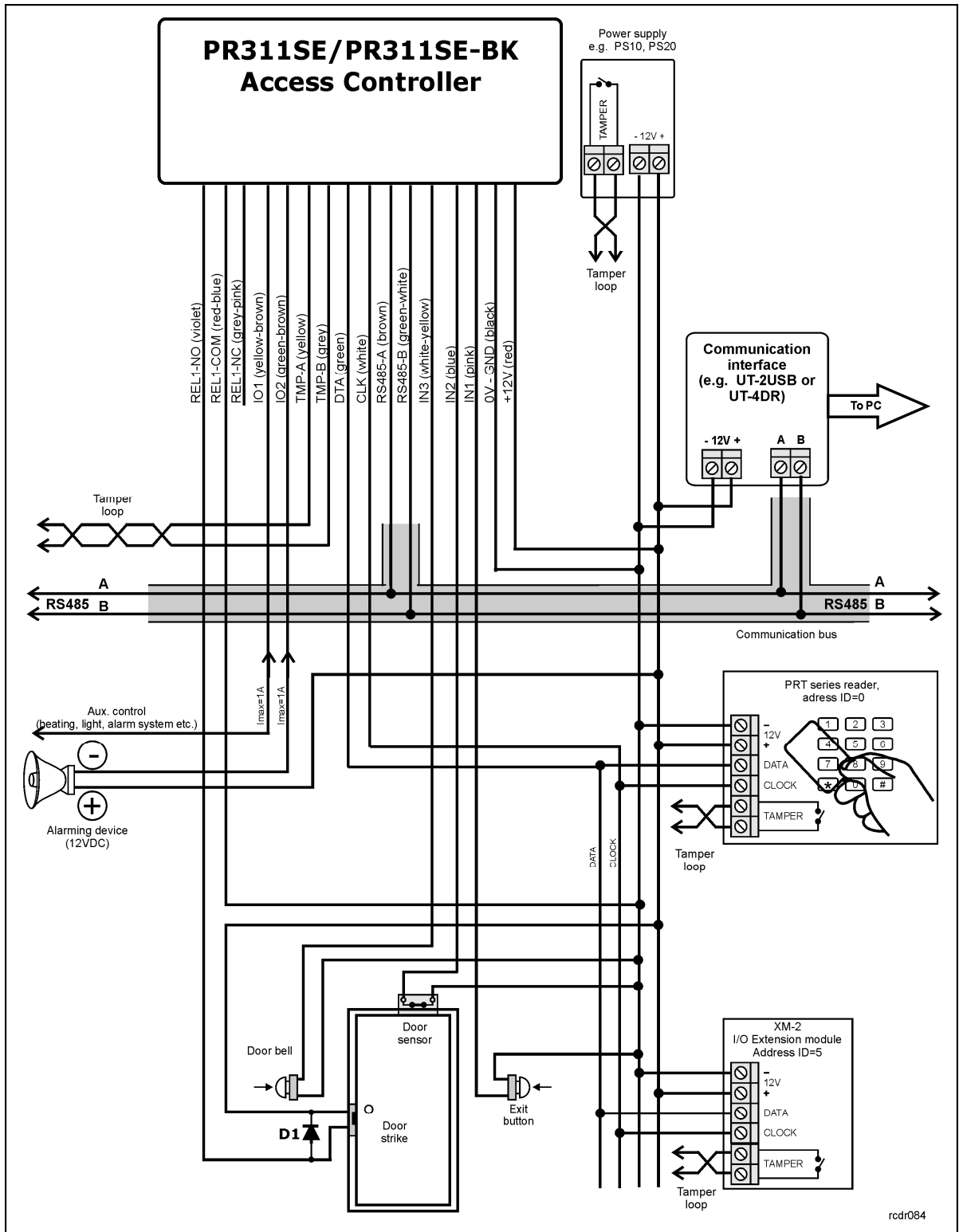





Fig. 1 PR311SE connection diagram

3.2 LED indicators

PR311SE controller is equipped with 3 LED indicators. Their functions and colours are specified in table 3 below. Functioning of LEDs can be verified by means of included MASTER card.

Table 3. LED indicators			
Symbol	Name	Colour	Description
	STATUS	Red/Green	Armed/Disarmed Mode respectively
	OPEN	Green	Door unlocking
	SYSTEM	Orange	Various system functions and programming

3.3 Power supply

The controller requires 12V DC nominal power supply. The power should be connected to the +12V wire and the GND wire. Additionally, the GND wire can be used as reference potential for the RS485 bus, IN1-IN3 input lines and RACS Clock&Data bus.

The power supply can be provided by means of power supply unit PS10 or PS20, which are available in Roger offer. The power supply units can be connected to backup battery in order to ensure operation of access control in case of power failure.

All devices connected to RS485 bus (including controllers) should have common supply minus (GND). In order to ensure this, all the GND terminals from various power supply units within the system should be connected with each other using separate wire. Alternatively, the common supply minus (GND) of the entire system can be earthed however in one, arbitrary selected point only.

Note: Do not connect positive terminals of power supply units with each other within the system.

3.4 Connection of door locking device

In majority of cases, door locking devices are inductive type. It means that turning off the current flow through the device causes the over voltage condition (voltage surges) which can interfere with the controller electronic components. In extreme cases it may result in improper operation of the controller or even freeze of the unit. Moreover, overvoltage condition causes quicker wear of the relay contacts. In order to limit this negative condition, it is necessary to use a general type semiconductor diode e.g. 1N4007 (one piece of such diode is included with the controller). It should be connected as close as possible to the inductive element (electric strike or magnetic lock).

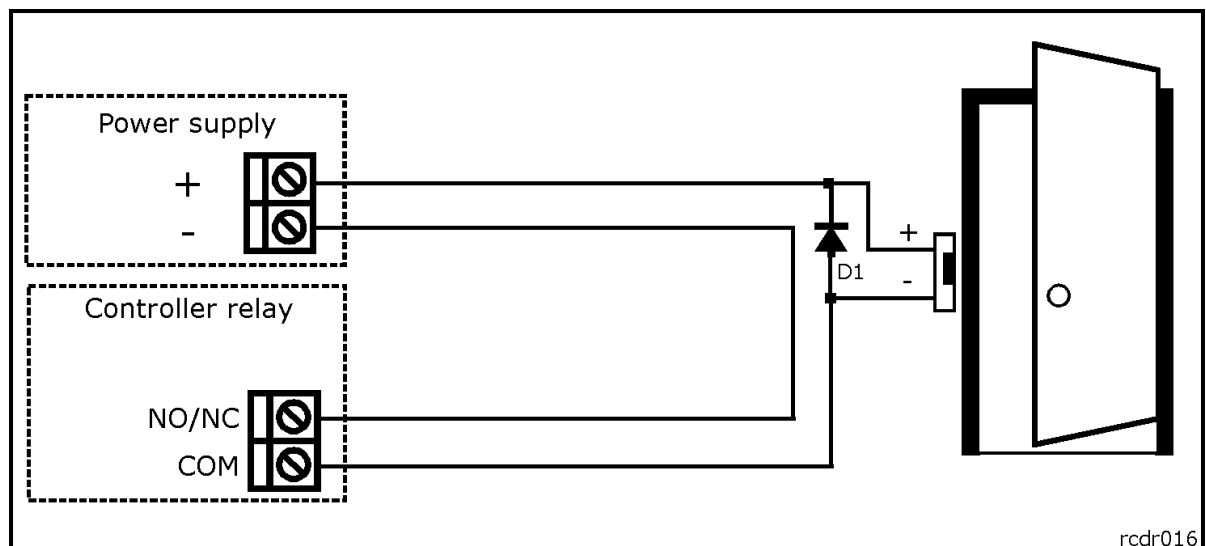

Fig. 2 Connection of door lock

3.5 Connection of external reader and/or extension module

PR311SE controller is equipped with built-in reader for EM 125kHz (UNIQUE) proximity cards and can operate with additional external reader of PRT series and/or XM-2 extension module. The address of external reader must be ID=0 (factory default address of PRT reader) and the address of XM-2 must be ID=5. Both mentioned device should be connected to CLK and DTA wires. Any type of cables (e.g. unshielded twisted pair) can be used for CLK and DTA lines. The guaranteed communication distance is 150 meters.

Note: Practically, devices communicating in RACS Clock&Data standard (e.g. PRT readers) can be connected to the controller for distances up to 500m, but it is not guaranteed by the manufacturer.

3.6 Input and output lines

The functions are assigned to input and outputs by means of PR Master software or by means of commands entered with controller keypad or external reader keypad (e.g. PRT12LT). Default function for REL1 relay output is door unlock.

3.6.1 Inputs

All inputs (IN1-IN3) of PR311SE have identical electric structure and can be configured as NO or NC lines. The NO input is triggered by shorting it to supply minus (GND) while the NC input must be normally shorted to supply minus (GND) and it becomes triggered when connection with ground is discontinued. Every input is internally connected to the power supply (+12V) through 15k Ω resistor.

3.6.2 Relay outputs

The relay output REL1 offers one switched contact rated 30V/1.5A. The relay contacts are internally protected against overvoltage by semiconductor elements. However this does not release the installer from responsibility to eliminate interferences from inductive elements by an additional diode. It is forbidden to use relay output to switch voltages above 30V because this for sure will cause damage to the semiconductor elements protecting the relay's contacts. In the normal state (the relay is off) the NC-COM contacts are shorted. In the triggering state (the relay is on) the NO-COM contacts are shorted. In case of lack of the power, the REL1 output is in the off state.

3.6.3 General purpose outputs

Two transistor outputs (IO1, IO2) are available in PR311SE controller. All these lines are open collector type, i.e. in the normal (off) state are pulled to supply plus via 15k Ω resistor and when on, they short to supply minus. Both lines can switch current up to 1A DC while voltage connected to the output must not exceed 15VDC. In case of overcurrent state, transistor outputs are automatically switched off and the controller automatically restarts.

3.7 RS485 communication bus

The RS485 bus consists of two signal lines A and B. In the RACS 4 system any topology can be used (star, tree or any combination of them, except for loop) in order to connect controllers in subsystem and to establish access control system. The matching resistors (terminators) connected at the ends of transmitting lines are not required. In most cases communication works with any cable type (standard telephone cable, shielded or unshielded twisted pair etc.) but the recommended cable is unshielded, twisted pair (UTP). Shielded cables should be limited to installations subject to strong electromagnetic interferences. The RS485 communication standard used in the RACS 4 system guarantees proper communication in a distance of up to 1200 meters as well as high resistance to interferences. UT-4DR communication interface can be used for communication of computer and PR Master software with remote (above 1200m) RACS 4 network (subsystem) of controllers. UT-4DR enables the communication through LAN/WAN.

3.8 Controller mounting

PR311SE enclosure consists of front panel and base. New device is assembled with standard base, but additional, extended base is included. The extended base can be used when connection cable must be hidden and no flush mounting box is available. Reference dimensions of PR311SE controller are shown in fig. 3 and fig. 4.

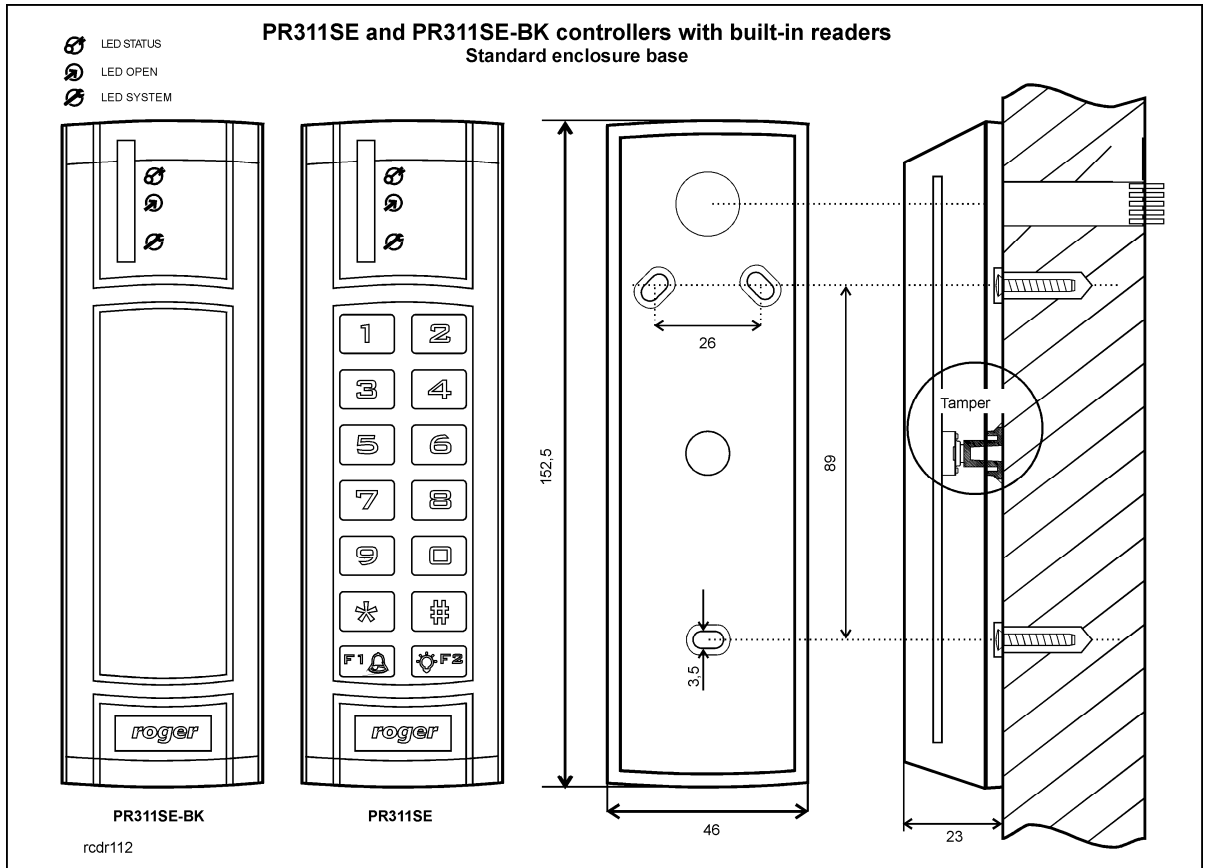

Fig. 3 PR311SE controller with standard enclosure base

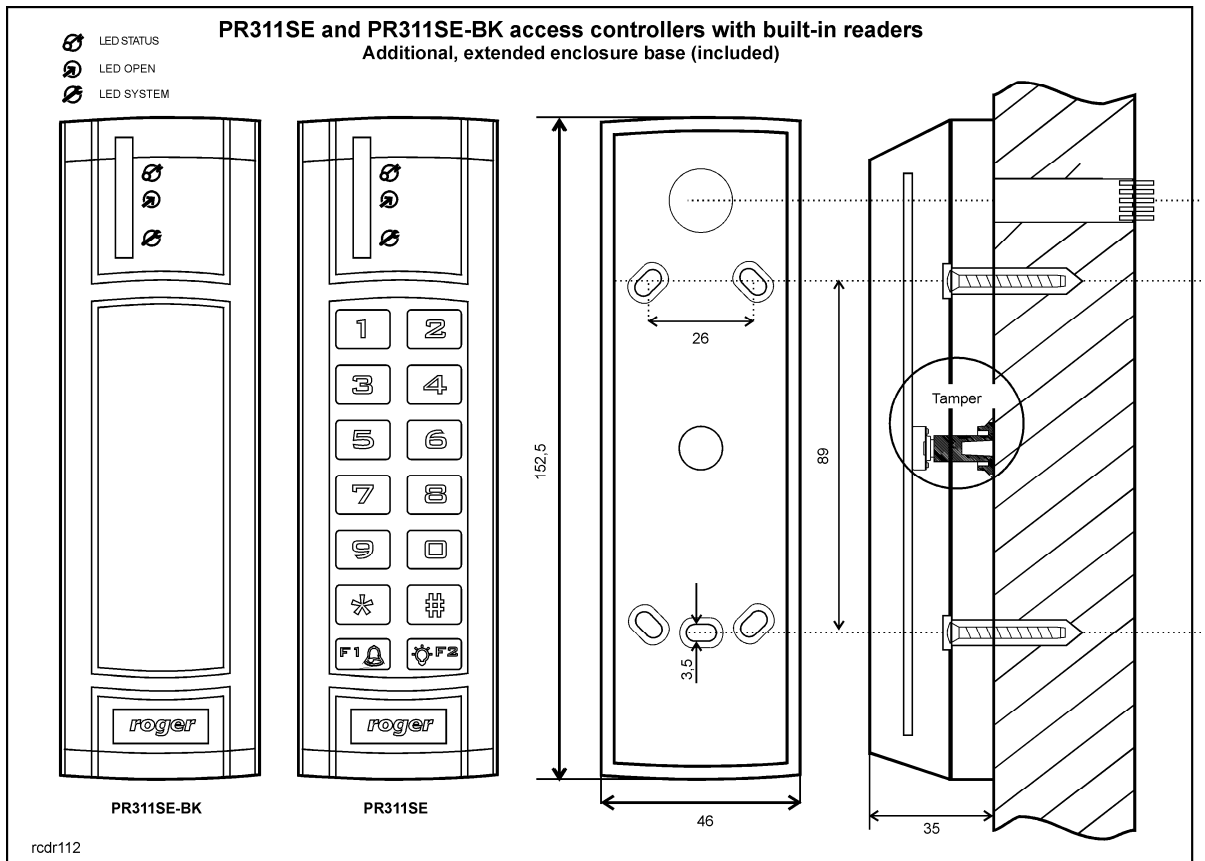

Fig. 4 PR311SE controller with additional enclosure base

3.8 Installation guidelines

- Install devices in such way as to ensure easy access to wires/terminals and jumpers (RST, FDM) located inside the controller.
- Prior to controller installation it is recommended to set its address (ID number) – see 4.1 Controller address. Factory default address is ID=00.
- The controller is delivered with MASTER proximity card, however any proximity card in EM 125kHz (UNIQUE) standard can be programmed as MASTER card.
- The controller should be installed at vertical wall in vicinity of controlled door.
- All electric cables must be connected to devices with disconnected power supply.
- All devices within RACS 4 system (controllers, readers, extension modules) should have common supply minus (GND). In order to ensure this, all the GND terminals from various power supply units used in the system (including access controllers with built-in power modules) should be connected with each other using separate wire. Alternatively, the common supply minus (GND) of the entire system can be earthed however in one, arbitrary selected, point only.
- A diode of general use e.g. 1N4007 should be always connected in parallel to the door locking device (magnetic lock, electric strike, relay coil) — one piece of such diode is delivered with the controller. It should be connected as close as possible to the inductive element.
- It is recommended to supply door locking device by means of separate wires, directly connected to power supply unit.
- It is recommended to install controllers/readers in minimal distance of 0,5m from each other.
- Because of relatively low magnetic field, the reader should not interfere with other devices, however its operation can be disrupted by devices generating a strong electromagnetic field.
- If the range of card reading is significantly lower than specified in technical documentation, consider relocation of controller/reader.
- Readers can be installed on metal surfaces but in such case reduction of reading distance should be expected. The reading distance reduction effect can be minimized by installing readers on the non-metal spacer with minimal thickness of 10 mm (e.g. PVC). If two readers have to be installed on opposite sides of the same wall, it is recommended that they are not directly opposite (in the same axis).
- In case of installation on rough surface (porous) it is recommended to use metal spacer AX-1 (Roger). The spacer can be also used as electromagnetic screen, which prevents cross interferences of controllers/readers. Installation of AX-1 may result in reduction of reading distance by approx. 20%, which in many installations is fully acceptable..

4. CONFIGURATION

4.1 Controller address

If PR311SE controller with built-in EM125kHz reader works autonomously (standalone mode), then address setting can be skipped (default address ID =00) but if the controller is to be connected with other controllers by means of RS485 bus and operate in network system, then it is necessary to assign unique address to particular controllers (ID number from range 00..99). Two or more devices with the same address cause communication conflict and make a proper communication with these devices impossible.

There are four methods of setting controller address:

- During update of controller firmware by means of Roger ISP software (so called Fixed ID)
- Manually, during Memory Reset procedure
- By means of PR Master software
- Manually, by means of commands entered with keypad

The first method is based on hardware address and the remaining ones are based on software addresses. The main difference between these two addressing methods is that software addresses can be changed in all possible ways while hardware address can be changed only during firmware update. Fixed ID has the highest priority and the other methods have lower priority.

Note: A new controller can be connected to the existing system without the necessity to change its address, but only if no other controller operates with default address ID=00. Once the controller is connected to the RS485 communication bus, it should be detected by means of PR Master software and required address can be set. It is recommended to assign addresses to all controllers as to make default address ID=00 unoccupied.

4.1.1 Setting the address during firmware update (Fixed ID)

FixedID can be set during update of the controller firmware by means of ROGER ISP software. Prior to firmware upload, Roger ISP software offers the possibility to set Fixed ID address in range of 00..99. Once the FixedID is selected and uploaded to the controller it is not possible to change it until the next firmware update. If FixedID address is not required operator should select FixedID=None.

Note: When using FixedID address no other method except firmware update can be used to change controller address again. The FixedID address is saved even in case of controller configuration error. Thanks to this feature controller can be always detected on the communication bus by means of PR Master software with the same address as it was assigned during firmware update.

4.1.2 Manual address setting during Memory Reset procedure

When hardware address is not used (i.e. FixedID=None) then the controller address can be set manually during Memory Reset procedure – see 4.2 Memory Reset procedure.

Note: If controller works with Fixed ID then Memory Reset procedure can be executed but still the new software address shall not be effective.

4.1.3 Setting the address by means of PR Master software







In order to set or change the address by means of PR Master software, the controller must be connected to PC via communication interface (UT-2USB, UT-4DR or RUD-1) and detected by the software. Once it is detected you can use Change ID command.

Note: The address, which is set manually during Memory Reset procedure can be changed by means of PR Master software and by means of manual commands entered with keypad.

4.1.4. Manual address setting by means of commands entered with keypad

All commands for manual programming of controller by means of keypad are specified in the document – PRxx1 series controllers, Functional description and Programming Guide, which is available at www.roger.pl.

Controller PR311SE-BK, which is not equipped with keypad can also be programmed manually. In such case it is just enough to connect PRT series reader with keypad (e.g. PRT12LT) to such controller. Procedure of manual address setting is as follows:



1. Enter 01# with keypad – the LED SYSTEM  shall switch on (orange) and LED OPEN  shall switch on (green).
2. Use MASTER card (included with the controller) twice – LED STATUS  shall switch on (red) and LED SYSTEM  shall switch on (orange).
3. Enter 40XX with keypad, where XX means the new address of the controller in range of 00-99
4. Enter 00# with keypad.
5. The controller shall return to normal mode, LED SYSTEM  shall switch off (orange) and LED STATUS  shall remain switched on.

4.2 Memory Reset procedure

Memory Reset procedure enables erasing of current settings and returning to default factory settings. It also allows to program new Master card and possibly MASTER PIN as well as new address of the controller. After Memory Reset procedure, the controller automatically enters normal working mode and is set in Armed Mode (LED STATUS  is red).

4.2.1 Simplified Memory Reset procedure (version 1)

This method erases controller memory and allows for programming of MASTER card however does not allow to program the controller address (address is automatically set to ID=00) nor MASTER PIN.

- Remove connections to CLK and DTA wires of the controller
- Connect CLK wire with DTA wire
- Restart the controller (place and remove jumper on RST contacts – see fig. 5 or switch power supply off/on) – all LED indicators shall be on and continuous acoustic signal shall be generated
- Disconnect CLK and DTA wires— the LEDs shall be off, and then LED OPEN  (green) shall blink
- While the LED OPEN  is blinking, read any card at the controller — this will be the new MASTER card
- The controller restarts automatically and switches to normal mode with address ID=00



4.2.2 Full Memory Reset procedure



Full Memory Reset allows for programming of new MASTER identifier (card and/or PIN) and setting controller ID address. In case of PR311SE-BK it is necessary to connect PRT series reader with keypad (e.g. PRT12LT) to perform Full Memory Reset.

- Remove connections to CLK and DTA wires of the controller
- Connect CLK wire with DTA wire
- Restart the controller (place and remove jumper on RST contacts – see fig. 5 or switch power supply off/on) – all LED indicators shall be on and continuous acoustic signal shall be generated
- Disconnect CLK and DTA wires— the LEDs shall be off, and then LED OPEN  (green) shall blink
- In case of PRT311SE-BK connect PRT series reader with keypad (e.g. PRT12LT) to CLK and DTA lines and execute further steps by means of that reader. In case of PR311SE, which is equipped with keypad, use controller keypad in further steps
- Enter new MASTER PIN (3-6 digits) followed with the [#] key or skip this step just pressing the [#] key
- Read any card at the controller — this will be the new MASTER card or skip this step just pressing the [#] key
- Enter two digits (in range of 00-99) by means of keypad – this will be new ID address or skip this step just pressing the [#] key and then default ID=00 shall be set
- The controller restarts automatically and switches to normal mode

4.2.2 Simplified Memory Reset procedure (version 2)

PR311SE-BK controller is not equipped with any keypad but it is possible to program MASTER card and controller ID address without connection of external PRT series reader. In such case, proceed as follows:

- Remove connections to CLK and IN3 wires of the controller
- Connect CLK wire with IN3 wire
- Restart the controller (place and remove jumper on RST contacts – see fig. 5 or switch power supply off/on) – all LED indicators shall be on and continuous acoustic signal shall be generated
- Disconnect CLK and IN3 wires— the LEDs shall be off, and then LED OPEN  (green) as well as LED STATUS  shall blink
- Read any card at the controller — this will be the new MASTER card. Then the controller shall generate two short acoustic signals
- Read MASTER card X times where X corresponds to the first digit of the required controller ID address. Then the controller shall generate two short acoustic signals
- Read MASTER card Y times where Y corresponds to the second digit of the required controller ID address. Then the controller shall generate three short acoustic signals
- The controller restarts automatically and switches to normal mode

After Memory Reset, the controller resumes its work with default factory settings and entered address. You can then test its operation using the MASTER card or PIN (if available). Using the MASTER card/PIN once activates the REL1 output for 4 seconds (LED OPEN  lights up for the time when REL1 is active). Using MASTER card/PIN twice switches the IO1 output to the opposite state and switches Arm/Disarm Mode (LED STATUS  changes its colour). After Memory Reset, Master identifier is identical as INSTALLER identifier, which is used in manual programming by means of commands.

Note: If the controller address is hardware type (see 4.1 Controller address) then address set during Memory Reset procedure is ignored.

4.3 Controller programming

PR311SE settings can be entered based on following methods:

- By means of PR Master software, which must be installed on computer. The computer must be connected to the controller by means of communication interface (e.g. UT-2USB, RUD-1, UT-4DR). PR Master software is available at www.roger.pl.
- By means of command entered with keypad (in case of PR311SE-BK it is required to connect any PRT series reader with keypad, e.g. PRT12LT).
- By means of Function Cards.

More information on controller programming can be found in the document – PRxx1 series controllers, Functional description and Programming Guide as well as in PR Master User Manual, which are available at www.roger.pl.

4.4 Firmware update

The latest version of firmware is available at www.roger.pl. In order to update firmware it is necessary to connect the device by means of RS485 bus to communication interface (UT-2USB, UT-4DR or RUD-1) and then connect the interface to PC with installed Roger ISP software. Roger ISP is available free of charge at www.roger.pl.

Firmware update procedure

- Connect power supply to the device
- Place jumper on FDM contacts

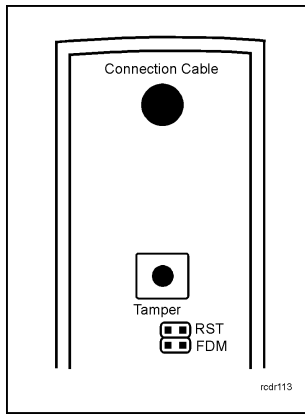

Fig. 5 Location of FDM and RST contacts inside the enclosure of PR311SE controller

- Reset the device (place and remove jumper on RST contacts or switch power off/on)
- Start RogerISP software and select communication port (in case of RUD-1 select RS-485).
- In Firmware window select firmware *.hex file (can be downloaded from www.roger.pl) and then select Program option.
- After firmware upload, remove jumper from FDM contacts and reset the device (place and remove jumper on RST contacts or switch power off/on).

In case of network system, it is required to restart controller within the main window of PR Master software by right clicking particular controller and selecting the option – Restart controller and verify version.

5. ORDERING INFORMATION

Table 4. Ordering information	
PR311SE	Access controller of standard PRxx1 series with built-in EM 125 kHz (UNIQUE) card reader, with keypad and with connection cable
PR311SE-BK	Access controller of standard PRxx1 series with built-in EM 125 kHz (UNIQUE) card reader, without keypad and with connection cable
PRT12-LT	EM125 kHz (UNIQUE) card reader
XM-2-BRD	Input/output addressable extension module, which provides two NO/NC inputs and two relay outputs with single switched contact NO/NC rated 30V/1.5A. Communication with host device can be performed using CLK/DTA lines. The module can be located in a distance of 150 m from the host device (controller).
RM-2	Module with two relay outputs, rated 30V/1.5A each with single switched contact NO/NC. Relays can be triggered by applying low or high voltage signal. Triggering of relay is indicated by LED on the module's board.
UT-4DR	Communication interface: Ethernet-RS485.
UT-2USB	Communication interface: USB-RS485.
UT-2	Communication interface: RS232-RS485.
RUD-1	Portable communication interface USB-RS485 with 12VDC output, which can supply connected controller.

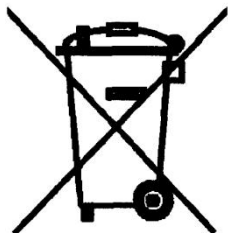
	<p>This symbol placed on a product or packaging indicates that the product should not be disposed of with other wastes as this may have a negative impact on the environment and health. The user is obliged to deliver equipment to the designated collection points of electric and electronic waste. For detailed information on recycling, contact your local authorities, waste disposal company or point of purchase. Separate collection and recycling of this type of waste contributes to the protection of the natural resources and is safe to health and the environment. Weight of the equipment is specified in the document.</p>
---	---

Contact:
Roger sp.j.
82-400 Sztum
Gościszewo 59
Tel.: +48 55 272 0132
Fax: +48 55 272 0133
Tech. support: +48 55 267 0126
E-mail: biuro@roger.pl
Web: www.roger.pl